



BOON EDAM
YOUR **ENTRY** EXPERTS.



BOON EDAM



LOW LEVEL SECURITY



WINGLOCK SWING.

THE **INTUITIVE** WIDE LANE SIDE GATE



OVERVIEW

Coordinating harmoniously with our Lifeline Series of speed gates, this wide lane side gate can form part of your existing combination of security gates or be used as a stand-alone solution. This single wing access gate is undeniably the slimmest in the market featuring modern, intelligent technology and an elegant, frameless wing.

As buildings get larger, with higher throughput, the need to manage more traffic flow rises. The Winglock Swing is the ideal secure entrance solution to handle disabled access or safe entry which requires a wide lane (such as bulky baggage or deliveries). Constructed from stainless steel and a single glass panel, the lane is elegant and unobtrusive in nature and design.

which averages 25 Watts. Compared to the industry standard of 200 Watts, this is energy-saving we are proud of.

Solid installation is guaranteed by a substantial floor mounting plate of 135 mm, alleviating the need for a supporting side post. Our engineers have gone so far as to develop alternative floor mounting fixes for common floor challenges – we have a solution for your unique installation.

AVAILABLE IN TALL AND DOUBLE

You can now order your side gate with tall glass panels (up to 1800 mm in height) or as a double glass version (up to 1400 mm in passage width). It is important to bear in mind that a tall glass version must also be configured as a double version to limit the impact forces - ensuring safety standards remain high.

The double glass panels are engineered to close using synchronised timing to reduce any risk of entrapment. Both of these options comply with the applicable standards without the need to add sensors.

EASY BI-DIRECTIONAL TRAFFIC

This aesthetic access gate has been designed to manage bi-directional traffic with effortless ease, using smart, intuitive technology to guide each visitor through to their destination without delay or inconvenience.

An array of proven and clear light signals indicate actions such as: in use, authorised, not authorised, closing and standby. They show as pulsing and quick blinking to guide your visitors through the access gate.

SUSTAINABLE, STABLE AND SECURE

The Winglock Swing has an impressively low carbon footprint, using only 9 Watts in Standby and 20 Watts when in motion. To illustrate the point, it uses less energy (even using it 24 / 7) than a laptop in standby mode

KEY FEATURES

- Slim modern design
- Frameless
- Invisible clamps
- Bi-directional
- External control panel integration
- Tamper and vandal resistant
- Small footprint
- Smooth swinging-motion glass wing
- Ergonomic design for customer comfort
- Intelligent and proven LED lights guide easy and clear passage
- Emergency egress (lock and motor disengage allowing free passage)
- Additional flexible options are available to fine-tune or 'Level Up'

KEY BENEFITS

- Transparent and unobtrusive
- Low carbon footprint – economical
- Wide passage for disabled access and goods delivery - even wider with the double glass option
- Works well as part of a larger (speed)lane configuration or as a stand-alone option
- High glass is possible to align with a speedlane
- Easy to clean and hygienic
- Uncomplicated to operate

SUGGESTED SEGMENTS

- Corporate offices
- Multi-storey tenant buildings
- Medical and pharmaceutical facilities
- Transportation Hubs
- Banks
- Public spaces (museums, cinemas, swimming pools)
- Schools, universities and colleges
- Sports facilities
- Government and embassy buildings

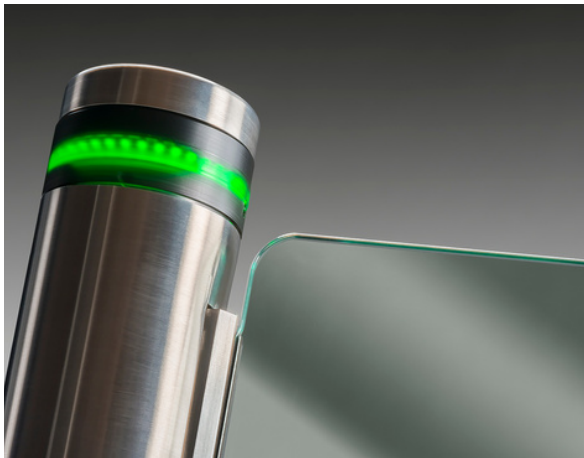

PUTTING THE POWER BACK IN YOUR HANDS

One size does not fit all, and that is why we at Boon Edam believe in offering modular solutions. This approach allows the security professional to design a tailored entrance solution that balances security and safety with aesthetics.

The result is a unique entrance that fits the needs of each industry, application and individual company. To get started, choose from an array of quality standard options. Then, 'Level Up' where it matters most to your company – whether that be in terms of throughput, security, safety, aesthetics, technology or user comfort – or a combination of each. A modular solution approach truly puts the power back into your hands - the power to create a refined entry with ease.

SCALABLE FLEXIBILITY IS THE FUTURE

The ability to integrate secondary security technology or visitor management software into our access gates is the ideal way to fine-tune or "Level Up" your entrance. In this case by adding these features under the security consideration, you can easily heighten the amount of protection offered by your gate.

Meeting your security goal easily and within your budget is the reason why we work together with you to ensure that by using these options, you end up with a product that outperforms the others safely, beautifully and profitably.

You can level up in any of these categories:

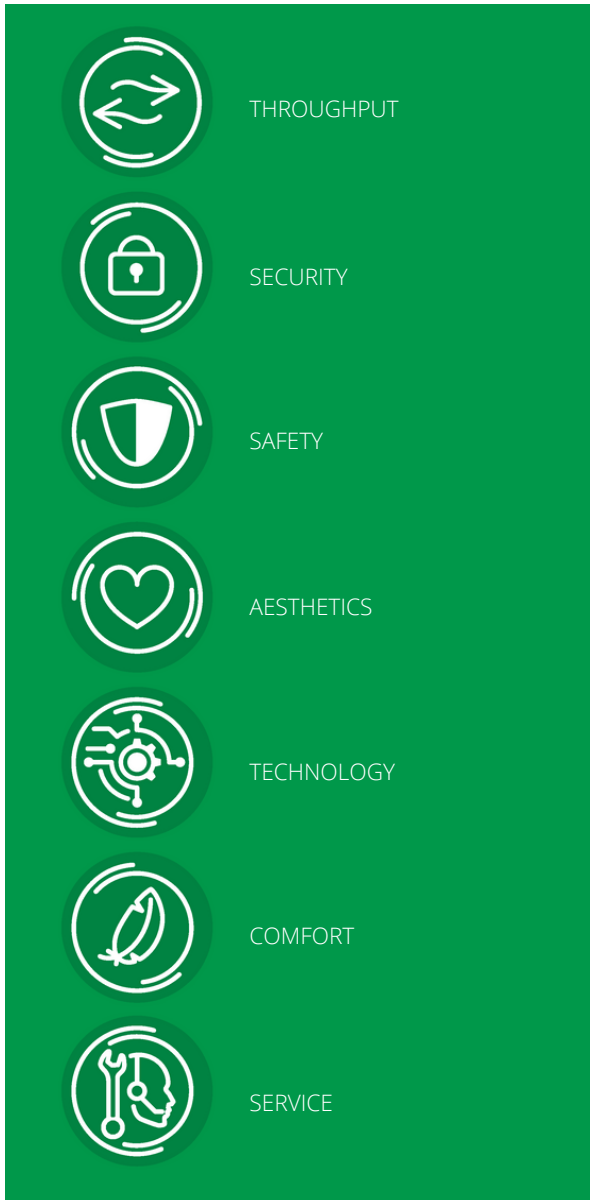

LEVEL UP

If our standard specifications do not quite suit your needs, we open up opportunities for you to 'Level Up' where it counts most. You can also do this according to your most motivating value driver.

The specification table shows you our standard product options, and to the right of these, you can easily see, and consider, any compatible 'Level Up' options for fine-tuning the Winglock Swing.



Standard single-wing option



Tall glass option with double panels

TECHNICAL SPECIFICATIONS

 THROUGHPUT	STANDARD	LEVEL UP OPTIONS
Throughput	30 People per minute	
Post Width	90 mm	
Post Height	1035 mm	
Passage Width	915 mm (single)	1750 mm (double) Tall glass: 915 / 1400 mm (double)
Number of Wings	1 (single)	2 (double)
Wing Height	940 / 980 mm (low)	Tall glass: 1200 - 1400 - 1600 - 1800 mm
 SECURITY	STANDARD	LEVEL UP OPTIONS
Unauthorised User Detection	-	
Booking Signal	-	
Sound Alarm	-	
Tailgating Detection	-	
 SAFETY	STANDARD	LEVEL UP OPTIONS
Fail Safe Operation	Lock will disengage in the event of a power failure	
Fire Alarm Connection	Emergency egress settings depending on local regulations and/or customer request	
Emergency Opening	Wing(s) can open 90°	Asynchronised closing cycle (double)
 AESTHETICS	STANDARD	LEVEL UP OPTIONS
Wing Material	10 mm tempered glass	
Cabinet Material	Stainless steel	Other Colours: On special request Branding: On special request
 TECHNOLOGY	STANDARD	LEVEL UP OPTIONS
Power Supply	100 - 240VAC, 24VDC	INTEGRATION OPPORTUNITIES:
Operating Power	20W (single) / 40W (double)	<ul style="list-style-type: none"> BoonTouch External Control Panel (up to 6 lanes) The Lifeline Boost
Operating Temperature	-20°C to +50°C	
Weight	48 kg (single) / 96 kg (double) depending on the glass height	
Access Control Systems	Dry contacts for virtually any access control device	
Card Reader Mount	-	Access Control System Pedestal
 COMFORT	STANDARD	LEVEL UP OPTIONS
Disabled Access	The standard passage width allows for disabled access	
Intuition	LED ring on top of the post provides user feedback	
Stand-by Power Consumption	Stationary 9W (single) 18W (double)	

6 WORKING PRINCIPLE

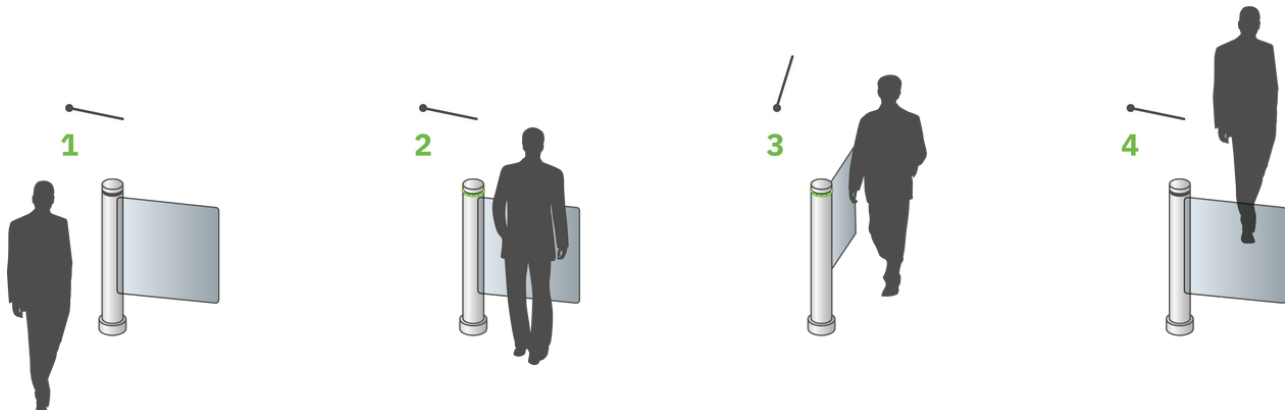

TECHNICAL DIMENSIONS

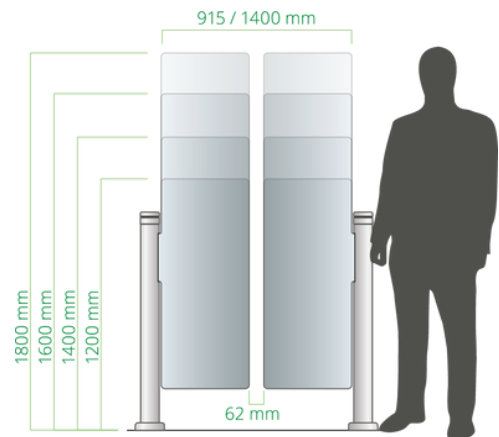
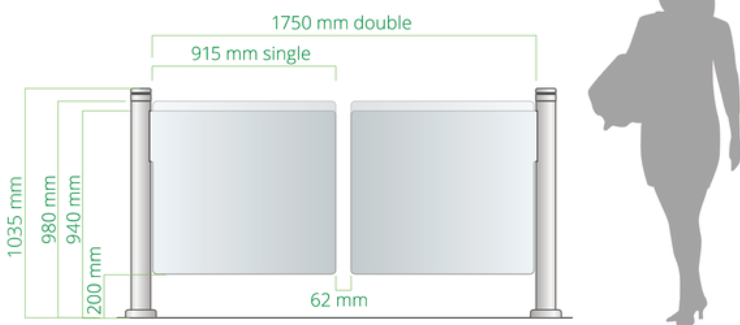
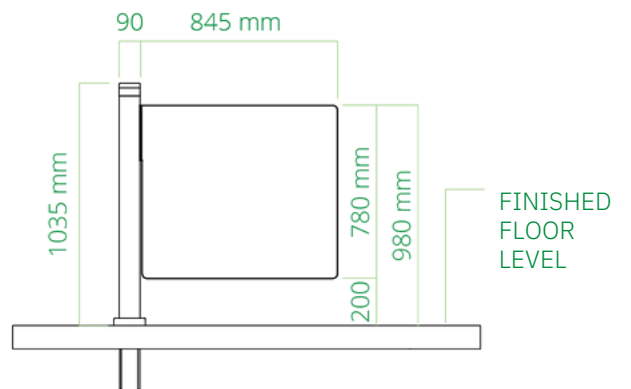
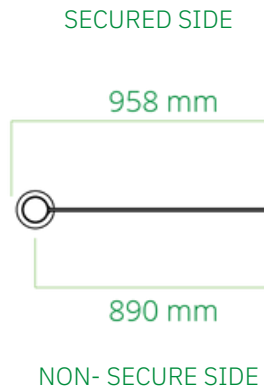
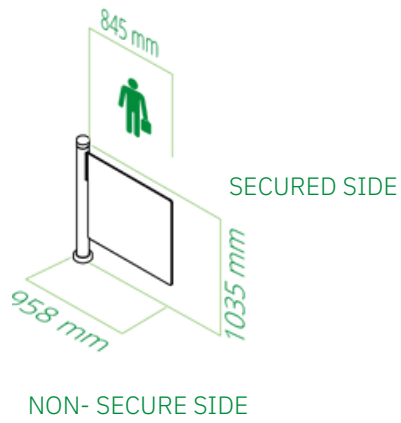



SERVICE AND MAINTENANCE

With hundreds or thousands of visitors passing through an entry every day, continued and reliable operation is vital. Regular service and maintenance can prevent unexpected hardware breakdowns. Boon Edam's service and maintenance teams across the world are experienced in the effects the local conditions have on the wear and tear of your entry solutions and can offer specialised service and maintenance contracts that correspond to those conditions perfectly.

COMPLIANCE

The goal of an organisation is to safeguard the valuable assets inside – both people and property. As is often the case, industries must comply with relevant local and global laws, policies and regulations to achieve the important goal of overall safety and security. Failure to meet the appropriate measures and criteria set out in these regulations could result in catastrophic incidents and substantial fines.

Boon Edam security entrances are trusted solutions that allow organisations to meet compliance regulations related to restricting access to areas within a building. We take compliance and safety very seriously and ensure that our products are manufactured, installed and maintained to keep up the strict criteria required in all our countries. We are always improving and always committed to making sure our products are compliant and certified. More information can be found on our website under 'About Us'.

The Winglock Swing complies with the following European standards:

- Machine Directive (2006/42/EC)
- BS EN 17352
- EMC Directive (2014/30/EU)
- Low Voltage Directive (2014/35/EU)
- RoHS Directive (2011/65/EU)



OUR REACH IS GLOBAL.

We have been in business for 150 years, manufacturing premium aesthetic and security entrance solutions in The Netherlands, the United States of America and China. We can confidently say that we cover every corner of the globe with subsidiary companies in major cities across the globe. Furthermore our global export division not only partner with our distributors, but also offer direct sales and service to every territory. This wide net allows us to have a strong global footprint and a personal grasp of local markets and their unique entry requirements.

To find your closest Boon Edam expert, please go to:
www.boonedam.co.uk/contact



Boon Edam Limited
T 01233 505 900
E uk.contact@boonedam.com
I www.boonedam.co.uk

V1-2212

BOON EDAM
YOUR ENTRY EXPERTS.