



YLI ELECTRONIC

ANSI standard Heavy Duty Electric Strike



Patent: No.201320470904.1

Specification

| Model | Face Plate | Voltage | Current | Fail safe | Suitable for | Signal output | Weight |
|----------------|------------------------------------|---------------------------|-------------------------|----------------------------------|---|---------------|--------|
| YS-138 | 124Lx43Wx35H | 12VDC (24V need order) | 12V/320mA; 24V/160mA | Fail secure(NO) Fail safe(NC) | Wooden door Metal door Glass door | No | 0.38kg |
| YS-138-S | 124Lx43Wx35H | 12VDC (24V need order) | 12V/320mA; 24V/160mA | Fail secure(NO) Fail safe(NC) | Wooden door Metal door Glass door | Yes | 0.38kg |
| YS-138L | 165Lx43.7Wx35H | 12VDC (24V need order) | 12V/320mA; 24V/160mA | Fail secure(NO) Fail safe(NC) | Wooden door Metal door Glass door | No | 0.40kg |
| YS-138L-S | 165Lx43.7Wx35H | 12VDC (24V need order) | 12V/320mA; 24V/160mA | Fail secure(NO) Fail safe(NC) | Wooden door Metal door Glass door | Yes | 0.40kg |
| YS-138LK | 250Lx43.7Wx35H | 12VDC (24V need order) | 12V/320mA; 24V/160mA | Fail secure(NO) Fail safe(NC) | Wooden door Metal door Glass door | No | 0.42kg |
| YS-138LK-S | 250Lx43.7Wx35H | 12VDC (24V need order) | 12V/320mA; 24V/160mA | Fail secure(NO) Fail safe(NC) | Wooden door Metal door Glass door | Yes | 0.42kg |
| Durable design | Mechanical test: 1, 000, 000 times | | | | | | |

Diagram(unit:mm)

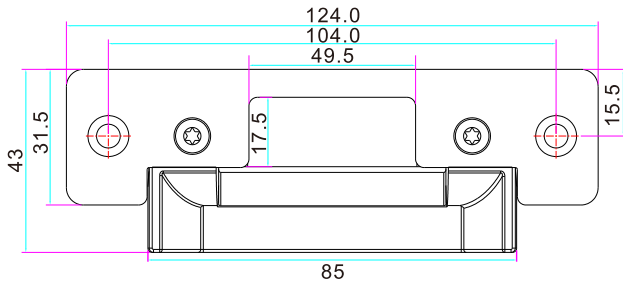

YS-138

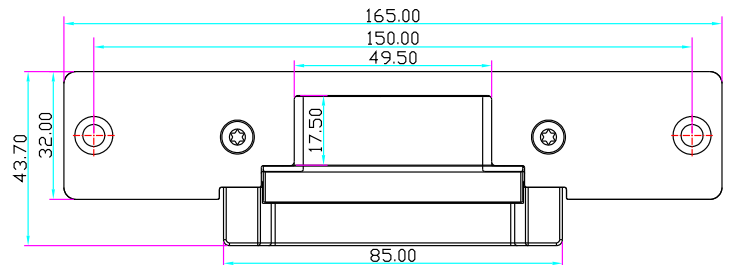

YS-138L

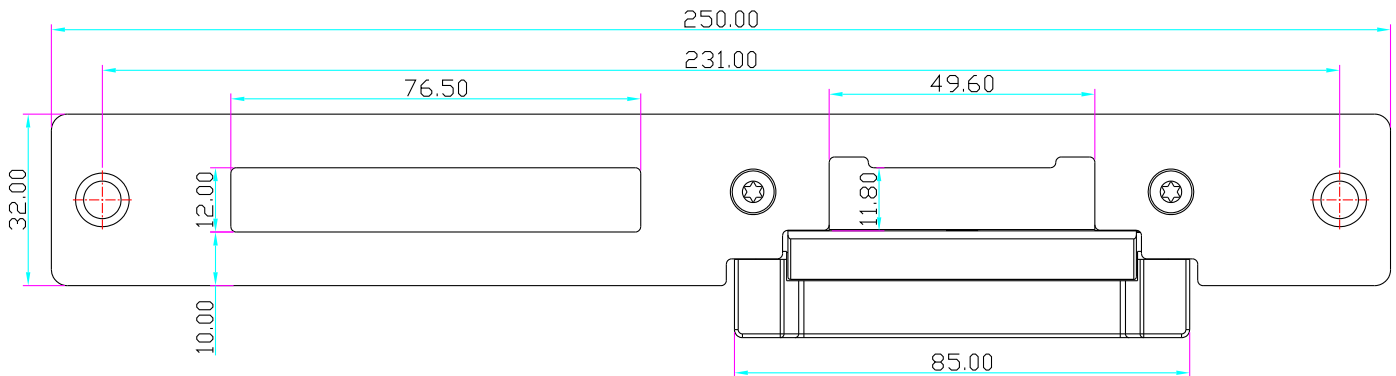

YS-138LK

Signal Output

Green: NO
White: COM
Yellow: NC

Door Status

N.C. contact output : open status
N.O. contact output : closed status

Red: +
Black: -

12VDC or 24VDC(need order)

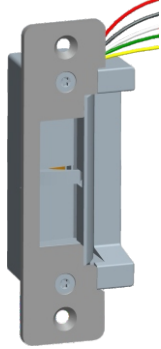

Accessories

If the door frame is too thick, please use the extension plate. Installation is as the follows.

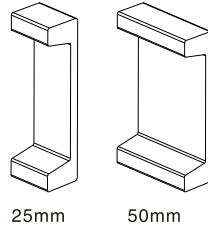

25mm 50mm
Extension plate

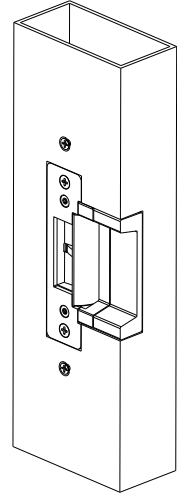

Function Conversion

You can set the operation mode of Fail Safe or Fail Secure.

Loose the screw and tighten it in the other hole.
Fail Safe(NC): When power off, the door is in the open status.

Fail Secure(NO): When power off, the door is in the closed status.

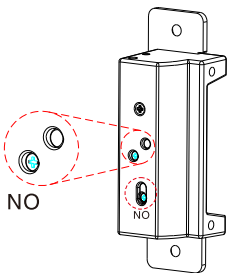

Fail Secure

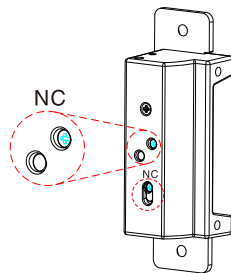

Fail Safe

Options of Mechanical Lock

Suitable for: YS-138, YS-138L

Suitable for: YS-138LK

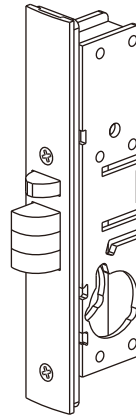

YS-305/306

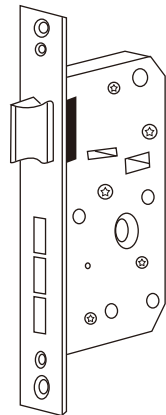

YS-308

Installation Diagram

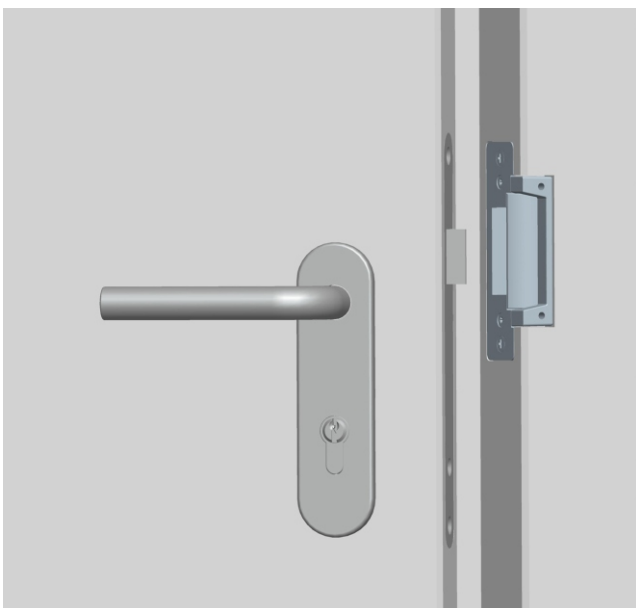

Overall Dimensions

